

2X 6088

2X 5672

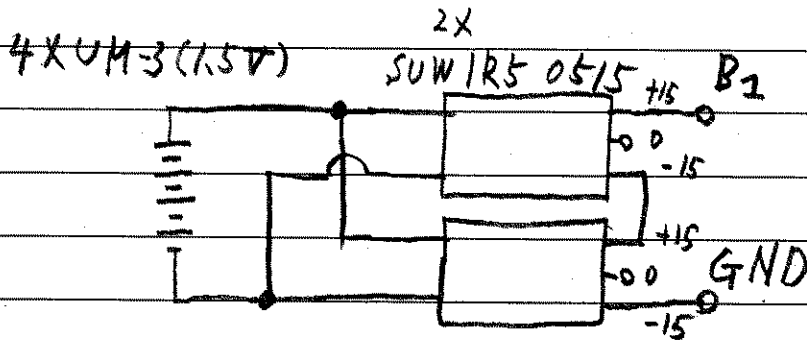

4X UM-3 (1.5V) GND

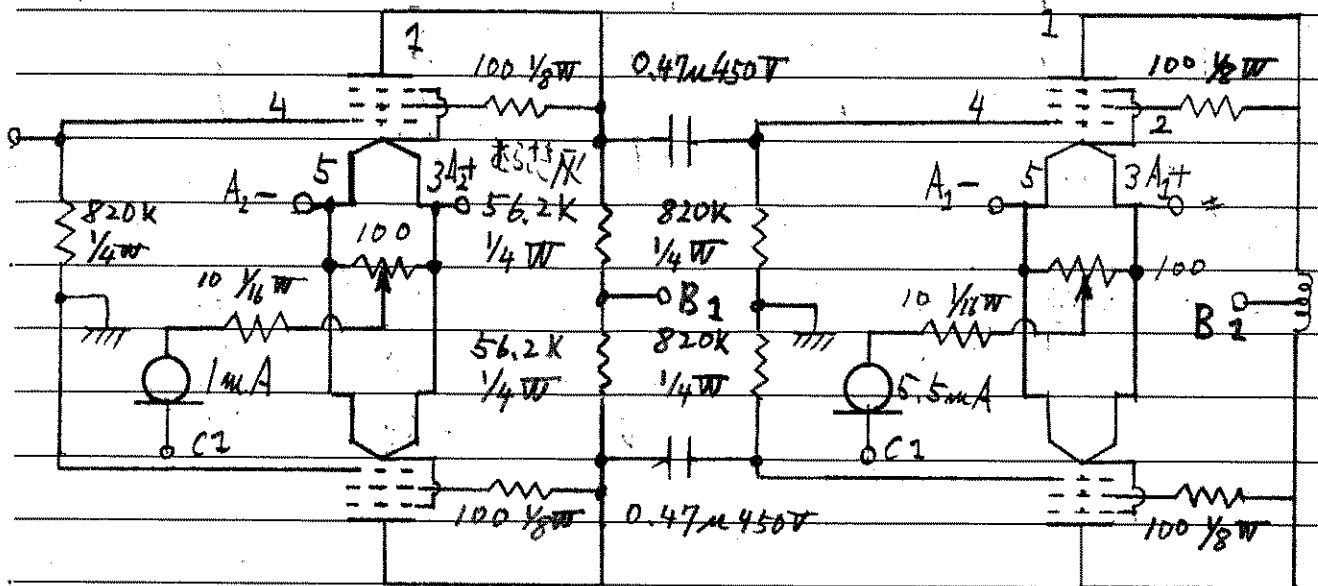

C7

UM-3 (1.2~1.5V) A_n+



A_n

n=1~4

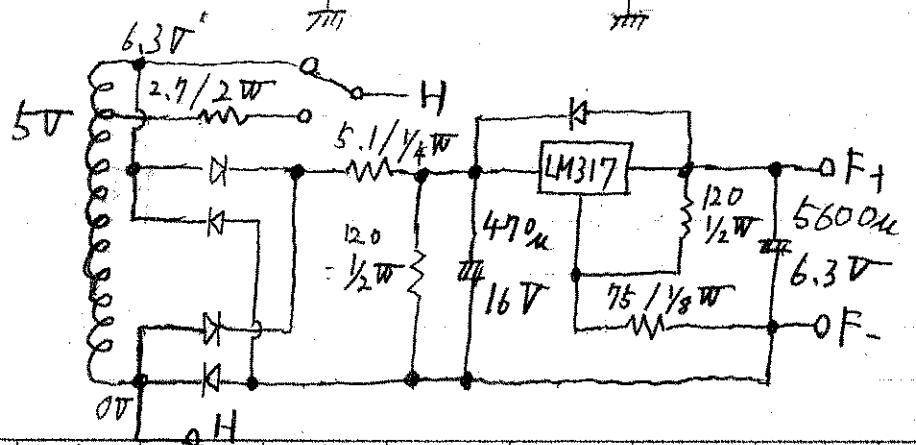
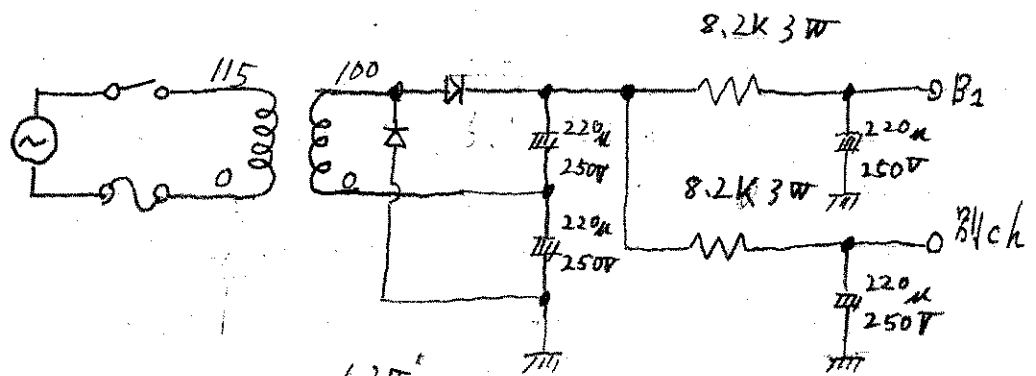
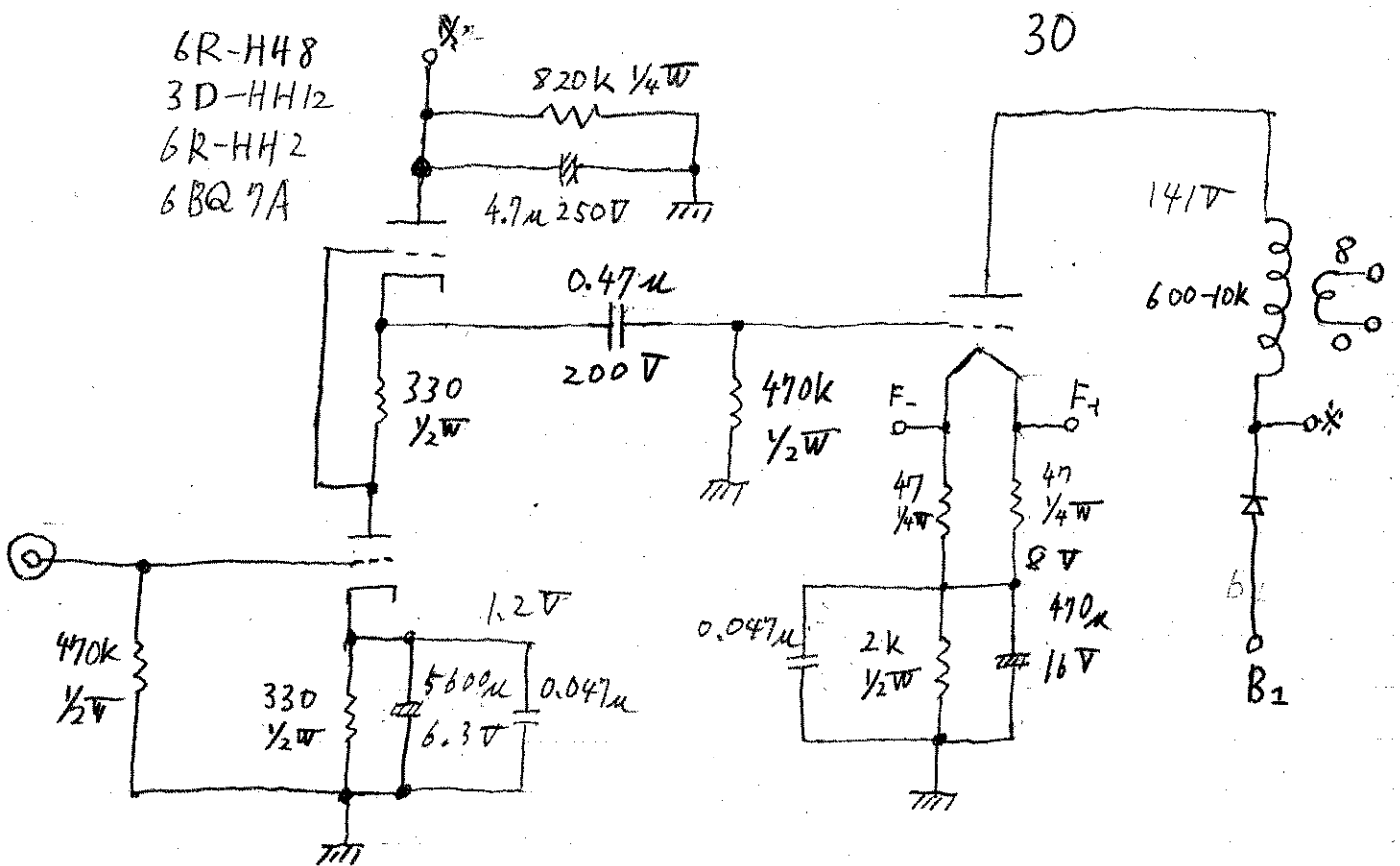

6BQ7A
 6R-HH 2
 3D-HH/2
 6R-HH8

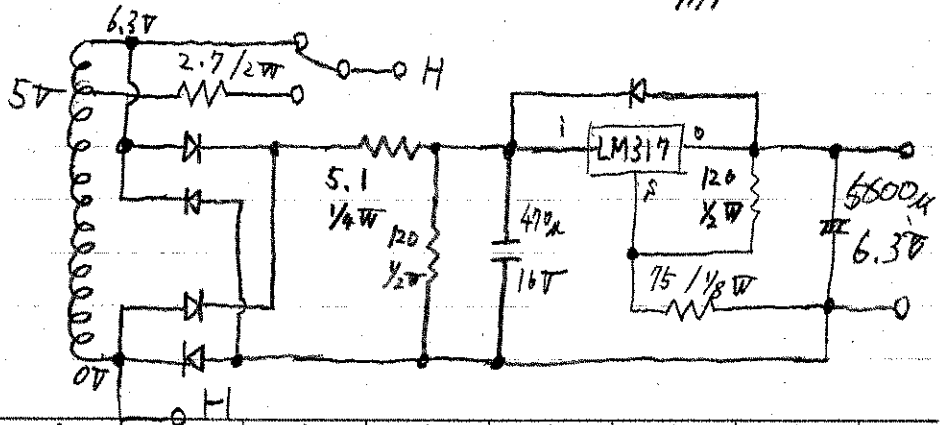
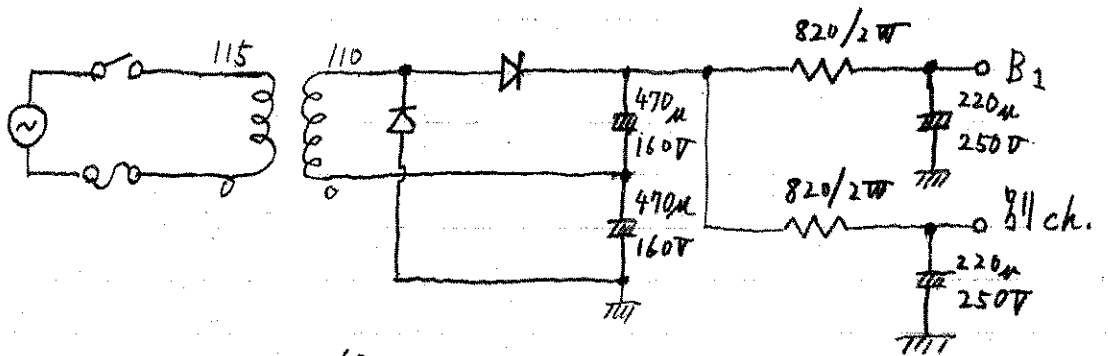
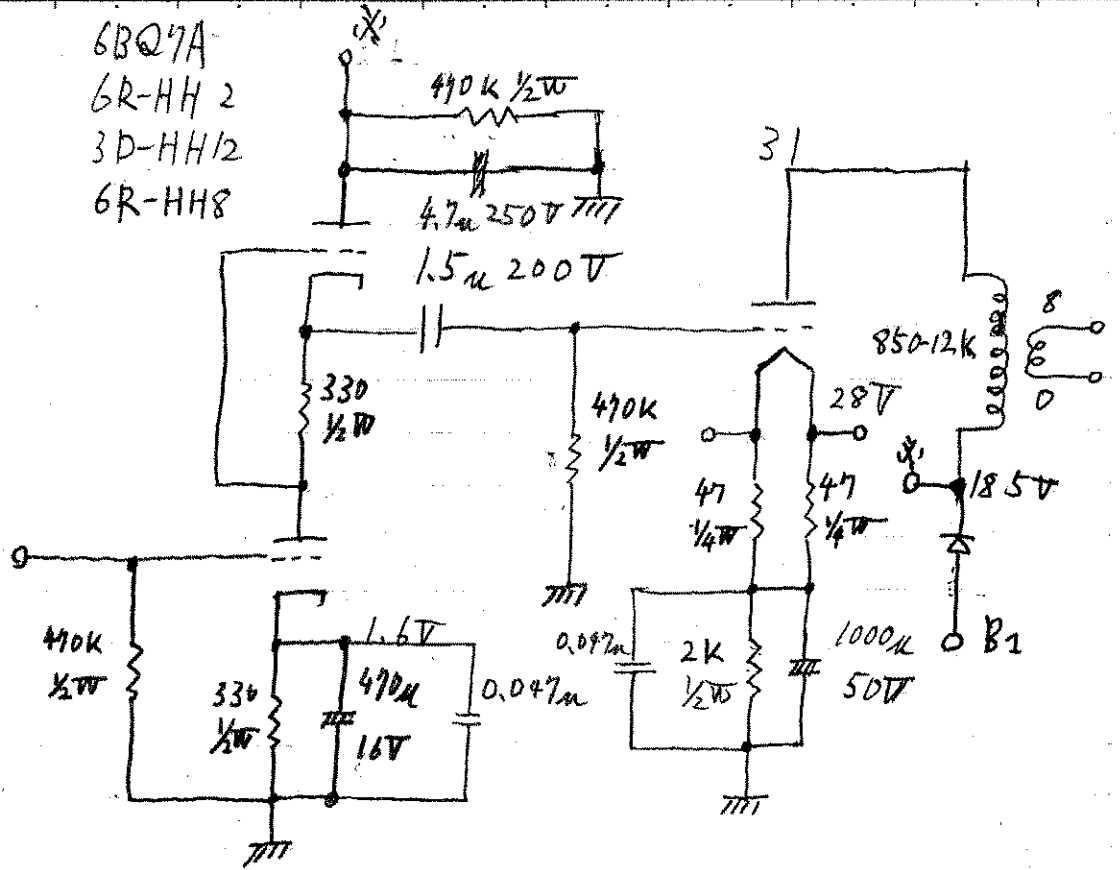

6R-HH8
 3D-HH12
 6R-HH2
 6BQ7A

33

