

スピーカー切替器

2018/4/27

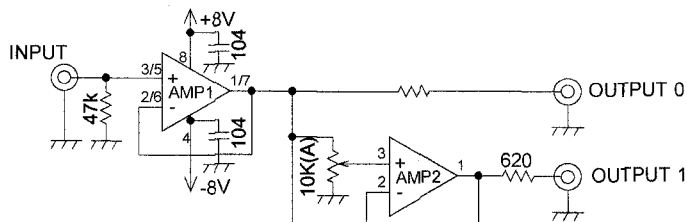

OPAMP 振り分け
 AMP1 INPUT L/R
 AMP2 OUTPUT R 1/2
 AMP3 OUTPUT R 3/4
 AMP4 OUTPUT R 5/6
 AMP5 OUTPUT L 1/2
 AMP6 OUTPUT L 3/4
 AMP7 OUTPUT L 5/6/2

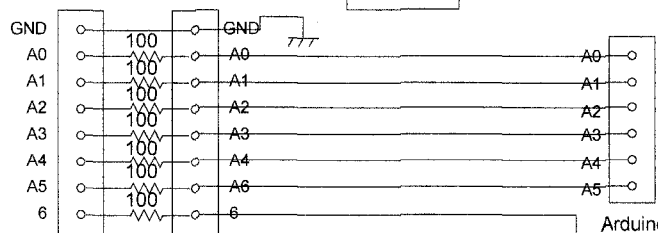
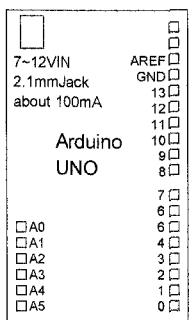

To 7seg LED Connector

カソード共通LED
 OSL 11001-LRA

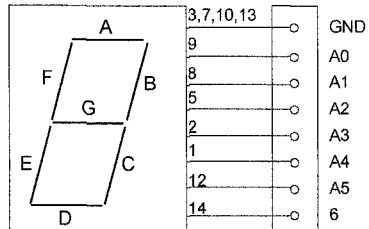

リモコン用追加コネクタ
 2020/04/03 追加装備

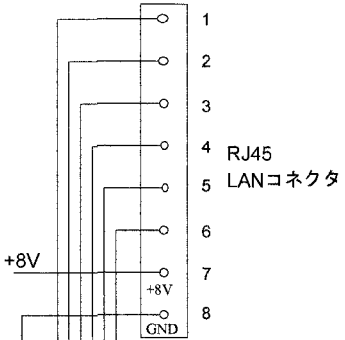

PUSH SW

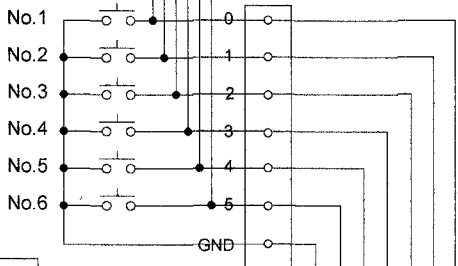

Arduino Connector

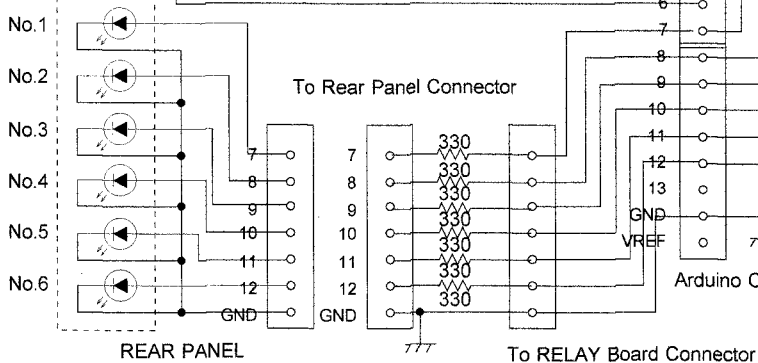

REAR PANEL

To RELAY Board Connector

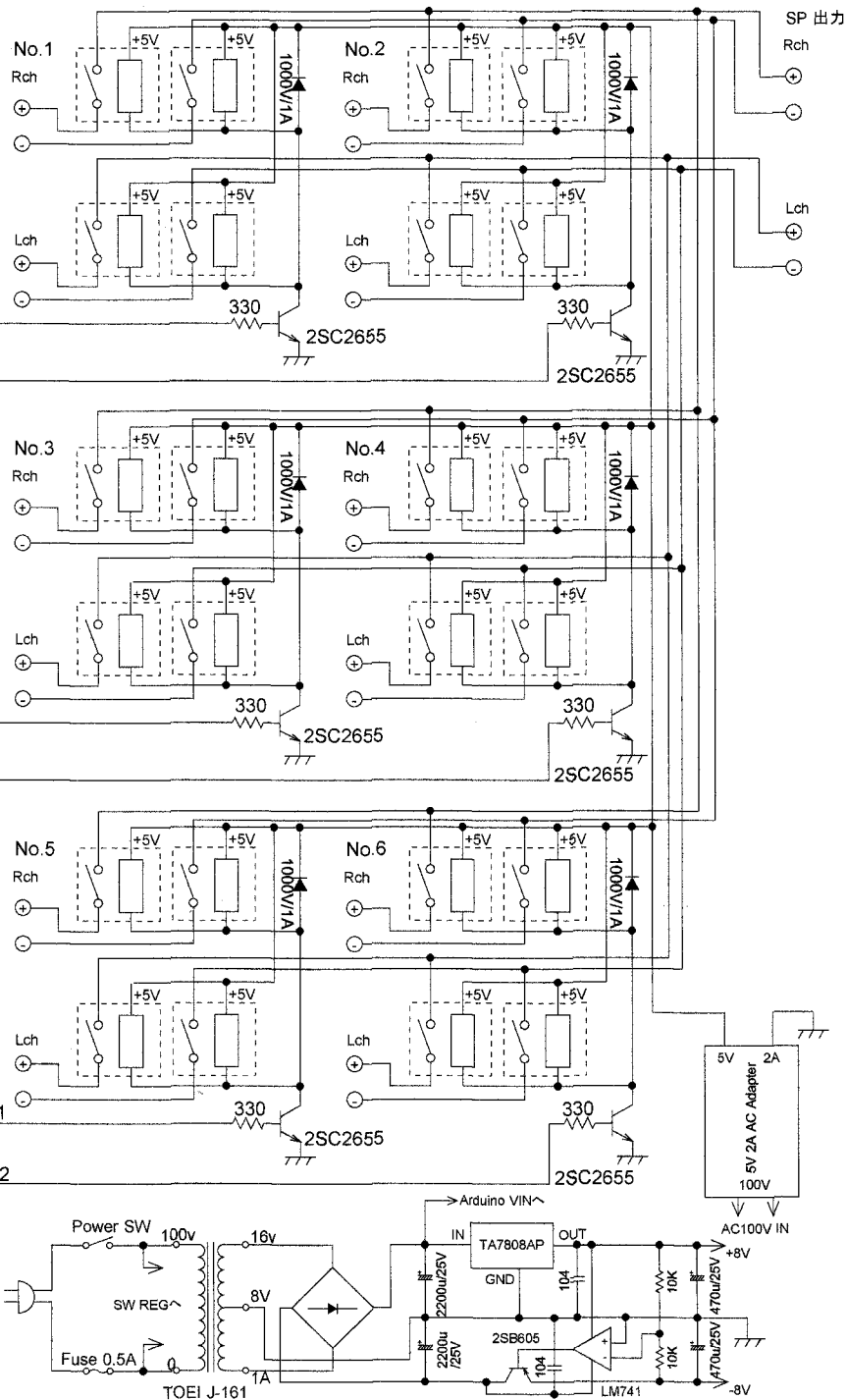

TOEI J-161

